

REVISION HISTORY					
DATE	REV.	CN NUMBER	DESCRIPTION	ZONE	BY
06-12-2018	A	CN92607	INITIAL RELEASE		J. PORTER
09-04-2018	B	CN93310	UPDATE TO MATCH BOM CHANGES, ADD MICROPHONE BOOT		FRK.ZHENG
01-07-2019	C	CN101200	Replace 62-5968-78/66-5968-45 with 5109834-00/5109835-00; Remove: 5086745.		FRK.ZHENG

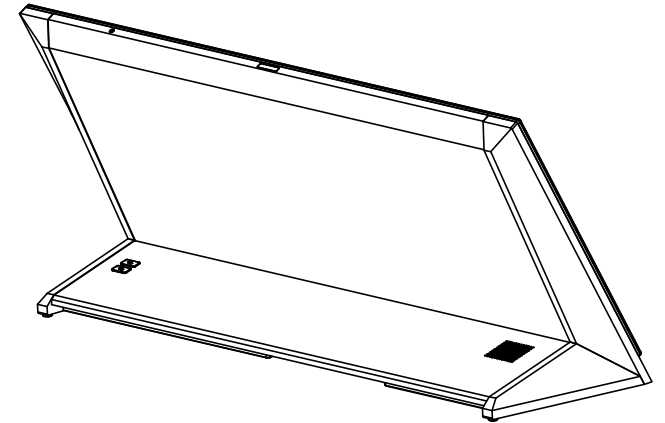
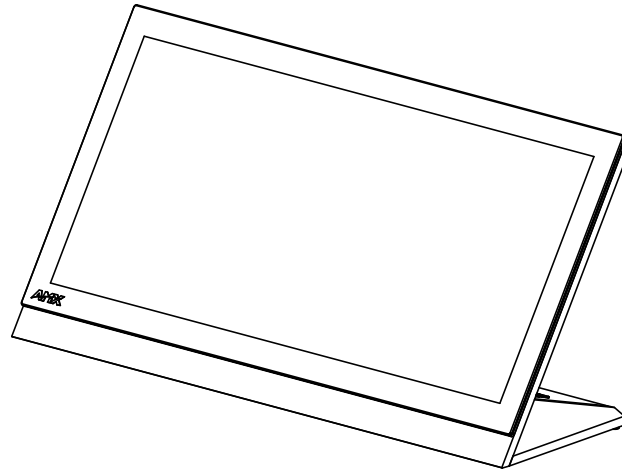
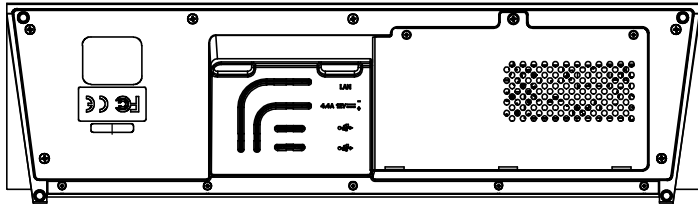
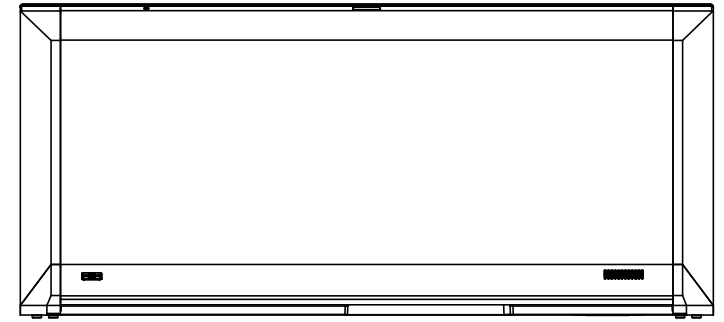
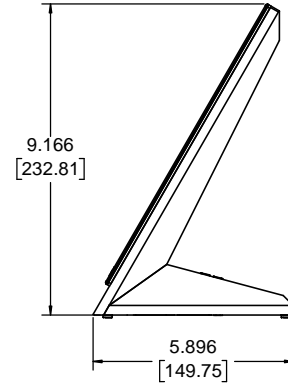
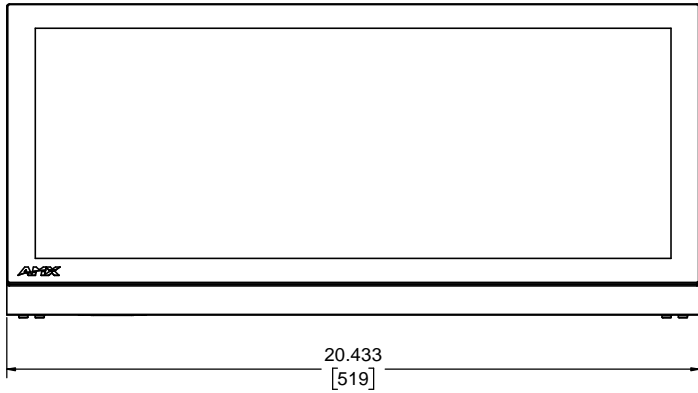
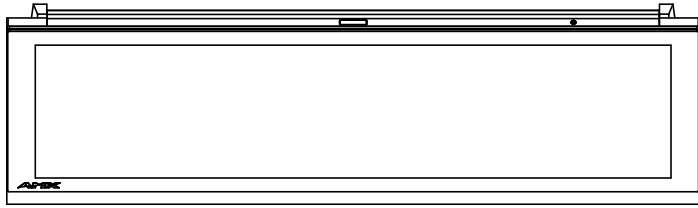

<b>ROHS/REACH</b> <small>PROPERTY OF HARMAN INTERNATIONAL COMPANY          ALL INFORMATION CONTAINED HEREIN IS UNCLASSIFIED EXCEPT WHERE SHOWN OTHERWISE          THIS DOCUMENT IS UNCLASSIFIED EXCEPT WHERE SHOWN OTHERWISE</small>	<b>FIRST ANGLE PROJECTION</b> 	 <b>HARMAN</b> DWG.ASY.MT-2002.20" MODERO TABLETOP
	<small>PROPERTY OF HARMAN INTERNATIONAL COMPANY          ALL INFORMATION CONTAINED HEREIN IS UNCLASSIFIED EXCEPT WHERE SHOWN OTHERWISE          THIS DOCUMENT IS UNCLASSIFIED EXCEPT WHERE SHOWN OTHERWISE</small>	
<small>PROPERTY OF HARMAN INTERNATIONAL COMPANY          ALL INFORMATION CONTAINED HEREIN IS UNCLASSIFIED EXCEPT WHERE SHOWN OTHERWISE          THIS DOCUMENT IS UNCLASSIFIED EXCEPT WHERE SHOWN OTHERWISE</small>	<small>PROPERTY OF HARMAN INTERNATIONAL COMPANY          ALL INFORMATION CONTAINED HEREIN IS UNCLASSIFIED EXCEPT WHERE SHOWN OTHERWISE          THIS DOCUMENT IS UNCLASSIFIED EXCEPT WHERE SHOWN OTHERWISE</small>	<small>PROPERTY OF HARMAN INTERNATIONAL COMPANY          ALL INFORMATION CONTAINED HEREIN IS UNCLASSIFIED EXCEPT WHERE SHOWN OTHERWISE          THIS DOCUMENT IS UNCLASSIFIED EXCEPT WHERE SHOWN OTHERWISE</small>